

General Conference

Activity Packet

April 4 & 5, 2009

My Eternal Family—Primary Theme for 2009

*“Happiness in family life is most likely to be achieved when
founded upon the teachings of the Lord Jesus Christ”
 (“The Family: A Proclamation to the World,” paragraph 7).*

Write a few notes or **draw** a picture about what these speakers talk about.

Color the tie to match what the speaker wore.

Circle your favorite talk and **write** something you will try to do better.

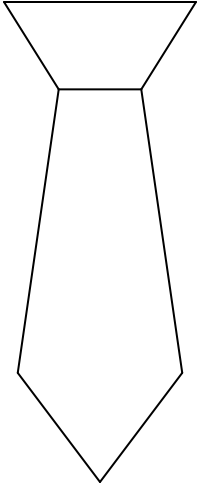

Thomas S. Monson
President

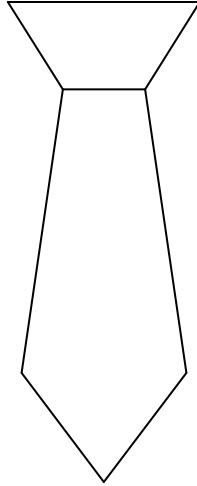

Henry B. Eyring
1st Counselor

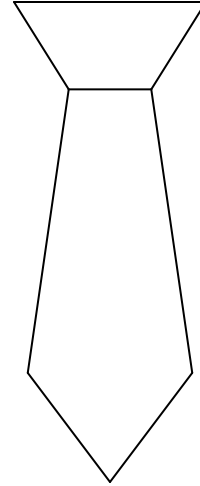

Dieter F. Uchtdorf
2nd Counselor

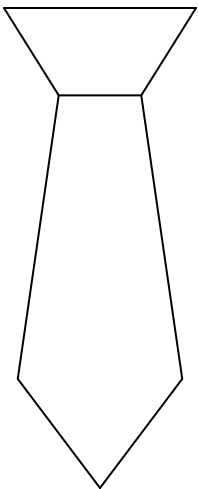

Boyd K. Packer
President of the
Quorum of the
12 Apostles

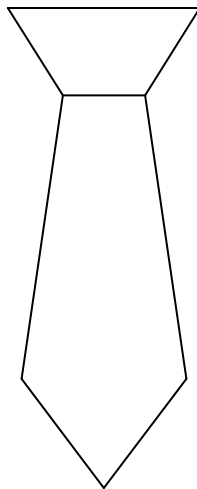

L. Tom Perry
Quorum of
the 12 Apostles

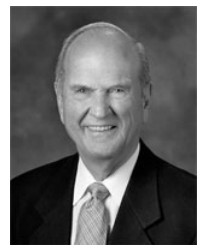
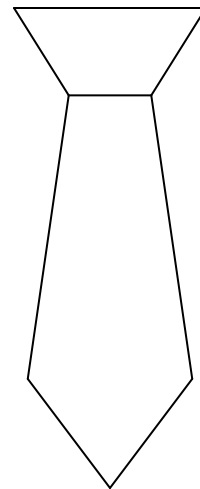

Russell M. Nelson
Quorum of
the 12 Apostles

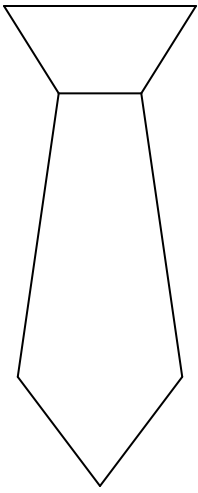

Dallin H. Oaks
Quorum of
the 12 Apostles

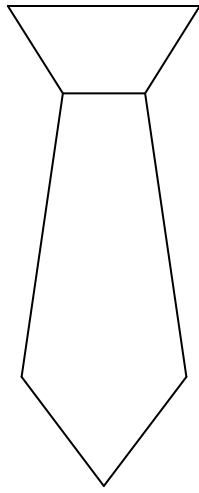

M. Russell Ballard
Quorum of
the 12 Apostles

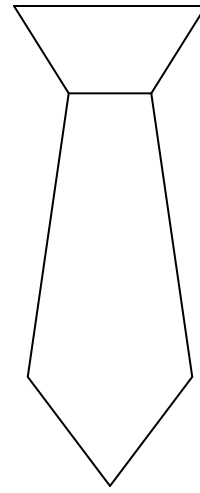

Richard G. Scott
Quorum of
the 12 Apostles

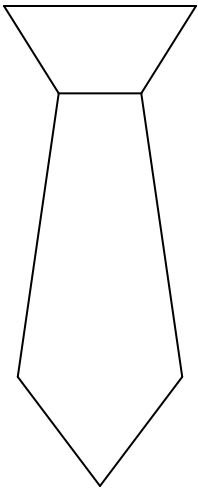

Robert D. Hales
Quorum of
the 12 Apostles

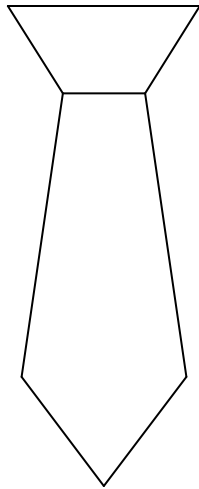

Jeffrey R. Holland
Quorum of
the 12 Apostles

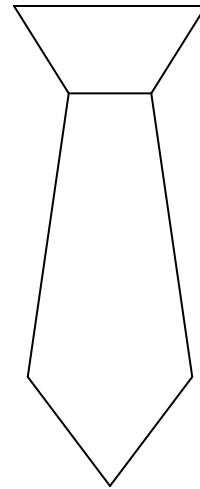

David A. Bednar
Quorum of
the 12 Apostles

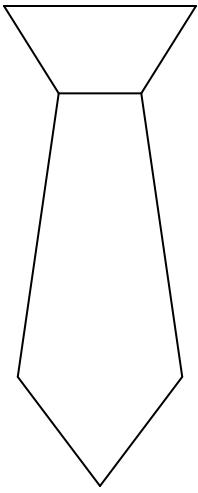

Quentin L. Cook
Quorum of
the 12 Apostles

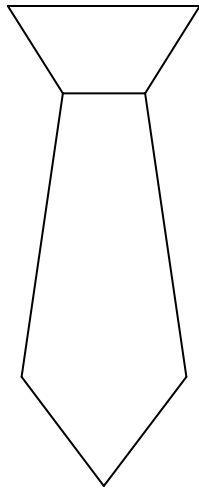

D. Todd Christofferson
Quorum of
the 12 Apostles

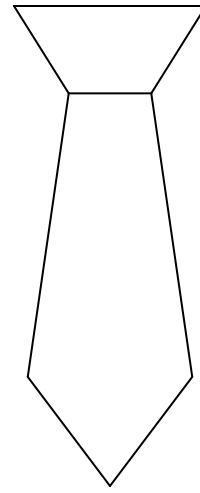

Quorum of
the 12 Apostles

List the names of others who spoke and their topic.

Who conducted each session?

Saturday Morning _____

Saturday Afternoon _____

Sunday Morning _____

Sunday Afternoon _____

What is the name of our new apostle? _____

How many members of the Church are there? _____

What is the Saturday night session called? _____

How many missions are there? _____

Were any new temples announced? If yes, where? _____

**Find your way through the maze to our living prophet,
President Monson.**

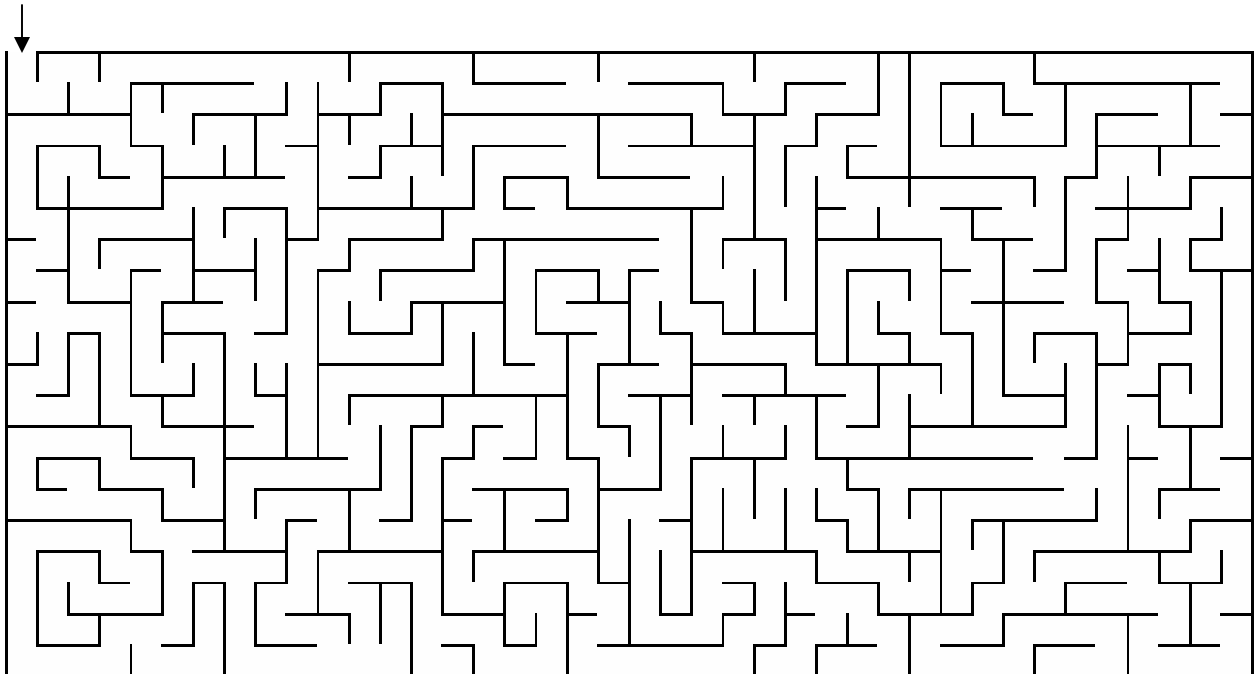

Now we have a world where people are confused.
If you don't believe it, go and watch the news.

We can get direction all along our way,
If we heed the prophets—follow what they say.



A
B
C
D
E
F



G
H
I
J
K
L



M
N
O
P
Q
R



S
T
U
V
W
X



Y
Z



President Thomas S.

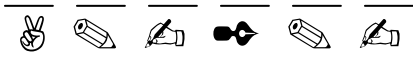

Elder M. Russell



President Henry B.

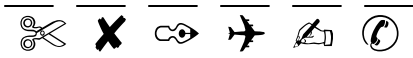

Elder Richard G. Scott

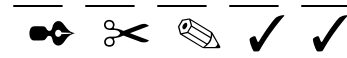

President Dieter F.

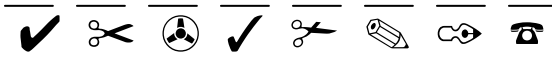

Elder Robert D.



President Boyd K.

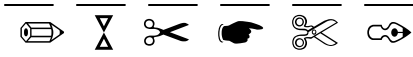

Elder Jeffrey R.



Elder L. Tom

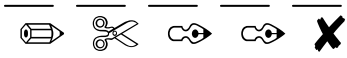

Elder David A.

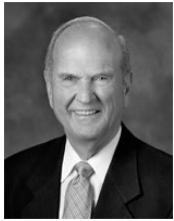
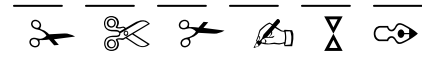

Elder Russell M.



Elder Quentin L.

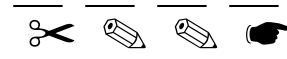

Elder Dallin H.

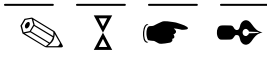

Elder D. Todd

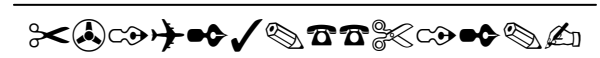

Match the first name with the last name. Then, find the names in the word search.
 Names are written .

C	Z	U	R	H	N	M	Z	K	F	X	D	Y	W	T
O	P	L	A	A	G	V	O	P	Y	D	X	F	O	T
O	E	B	N	L	D	N	D	T	D	M	R	O	J	O
K	R	R	D	E	R	R	O	O	L	E	H	H	V	C
S	R	Z	E	S	A	O	T	A	T	E	O	A	M	S
S	Y	H	B	L	H	D	N	E	K	E	L	Z	B	F
A	R	Q	L	Z	C	D	I	V	M	S	L	W	K	L
M	O	A	R	F	I	D	R	E	K	C	A	P	D	L
O	B	Z	F	Q	R	S	D	Y	E	U	N	C	Y	E
H	E	Y	R	I	N	G	V	B	E	J	D	Q	O	S
T	R	S	D	A	L	L	I	N	H	R	B	A	B	S
S	T	L	N	I	T	N	E	U	Q	V	F	W	M	U
O	D	Y	U	C	H	T	D	O	R	F	O	F	L	R
L	L	N	E	L	S	O	N	N	C	J	J	N	E	M
Y	D	A	V	I	D	A	S	O	Q	J	P	G	R	J

Russell M
 Richard G
 Henry B
 Thomas S
 Robert D
 Boyd K
 David A
 L Tom
 Quentin L
 Dallin H
 D Todd
 M Russell
 Jeffrey R
 Dieter F

Monson
 Packer
 Perry
 Nelson
 Oaks
 Ballard
 Scott
 Hales
 Holland
 Eyring
 Uchtdorf
 Bednar
 Cook
 Christofferson

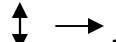
Word Find: Find the last names of the apostles.
 They will be found .

K	W	U	S	G	E	S	J	D	M	G	R	O	N	B
R	G	V	C	Q	O	J	K	R	C	A	G	O	O	W
Q	O	V	W	Y	A	N	S	A	H	U	I	U	S	B
E	C	R	R	M	B	O	G	L	R	X	O	P	N	E
G	X	Y	G	M	P	T	N	L	I	J	M	H	O	D
N	G	S	R	M	R	T	S	A	S	D	A	W	M	N
I	H	A	X	Z	U	O	K	B	T	P	U	R	K	A
R	A	Y	E	A	R	C	A	A	O	C	A	E	O	R
Y	H	K	P	Q	S	S	O	W	F	J	M	K	O	P
E	L	U	C	H	T	D	O	R	F	I	A	C	C	S
I	H	O	L	L	A	N	D	U	E	E	F	A	U	U
X	C	P	E	R	R	Y	R	D	R	F	W	P	L	J
N	E	L	S	O	N	F	Z	J	S	G	Q	T	Y	T
C	E	K	G	G	S	T	W	M	O	L	M	M	J	D
H	A	L	E	S	J	Z	Z	L	N	Y	V	R	E	A

Monson
 Packer
 Perry
 Nelson
 Oaks
 Ballard
 Scott
 Hales
 Holland
 Eyring
 Uchtdorf
 Bednar
 Cook
 Christofferson

R A L P M E X E T K H C
L S A V I O R F F C M R
P D J E S U S I F O O E
M N E P S W O R D R Q A
E S H L K C N S L E J T
S S O K I N G T I D U O
S T V N R V R B G E D R
I L A M B N E O H E G B
A C H R I S T R T M E R
H O L Y O N E N E E M E
W C M E D I A T O R J A
G O O D S H E P H E R D

BREAD	CHRIST	CREATOR	DELIVERER
EXEMPLAR	FIRSTBORN	GOOD SHEPHERD	
HOLY ONE	JEHOVAH	JESUS	JUDGE
KING	LAMB	LIGHT	MEDIATOR
MESSIAH	REDEEMER	ROCK	SAVIOR
SON	WORD		

Seek the Words of Christ

G E M N K E R U D N E B S L R R P P O G
T L M X L A P R I E S T H O O D H M I K
L B U Y R S E I R A N O I S S I M S B N
T I T H I N G M K A N P R A Y E R H V X
E B E X L Q L T N M S X H M J H T I A F
E O C B F O F E U E S P O T E H P O R P
C G I S V Z V S L R P D N C S C I Z H X
B O V E S O I F E C S P J C T R R T S Q
A D R L C C E H O I V Q R E N Q U H C T
P H E P G S T M W W S I A O T O P K H N
T E S M T A P F S F P C I N Y X S Q R E
I A P E F A O R A T H T O B M Y Q A I M
S D E T S D E M U E A I L A H Z T D S D
M M B S R H I R R R T A R I O O C B T N
L K I O T L E S A A A R H T N H Q E T A
M O W O I S E P C O I Q L E E T B A M M
N L M E I M E U C A V F M G S A Y H P M
X H S F Z R D X G U K E U A T E Q O W O
J Q V N P E D E J E N R F I Y D T R G C
O P A W U E P O H T Q B L E S S I N G S

General Conference Talk Subjects

Words will be found



Atonement	Honesty
Baptism	Hope
Bible	Jesus Christ
Bishop	Love
Blessings	Marriage
Book of Mormon	Missionaries
Chastity	Mothers
Children	Music
Christ	Obedience
Commandment	Prayer
Compassion	Preparation
Covenants	Priesthood
Death	Prophet
Education	Repentance
Endure	Resurrection
Eternal Life	Sabbath
Examples	Scriptures
Faith	Self-Esteem
Families	Service
Fathers	Teachers
Food Storage	Temples
Godhead	Tithing
Good Works	Word of Wisdom
Holy Ghost	Youth

Match the scripture with its reference.

“All of you are children of the most High.”

Job 19:25

“And ye will not have a mind to injure one another, but to live peaceably.”

“The family is ordained of God.”

Psalm 82:6

“I will give unto thee the keys of the kingdom of heaven; and whatsoever thou shalt bind on earth shall be bound in heaven; and whatsoever thou shalt loose on earth shall be loosed in heaven.”

“Organize yourselves; prepare every needful thing; and establish a house, even a house of prayer, a house of fasting, a house of faith, a house of learning, a house of glory, a house of order, a house of God.”

Matthew 16:19

John 3:5

John 14:6

Galatians 5:13

“What I the Lord have spoken, I have spoken, . . . Whether by mine own voice or by the voice of my servants, it is the same.”

“I am the way, the truth, and the life; no man cometh unto the Father, but by me.”

Mosiah 4:13

Doctrine & Covenants 1:38

“Except a man be born of water and of the Spirit, he cannot enter into the kingdom of God.”

Doctrine & Covenants 88:119

“The family is central to the Creator’s plan for the eternal destiny of His children.”

“Proclamation,” paragraph 1

“Successful . . . Families are established and maintained on principles of faith, prayer, repentance, [and] forgiveness.”









“Proclamation,” paragraph 7

“By love serve one another.”

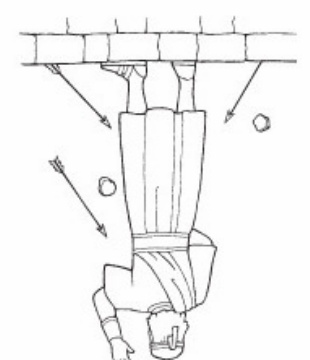
“Proclamation,” paragraph 7













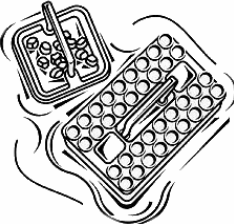







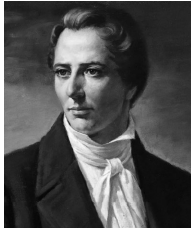



“I know that my redeemer liveth, and that he shall stand at the latter day upon the earth.”

This coloring page is from the new Nursery Manual—“Behold Your Little Ones.”

<p style="font-size: small;">I will follow the prophet.</p> 	<p style="font-size: small;">I will follow the prophet.</p> 	<p style="font-size: small;">I will follow the prophet.</p> 	<p style="font-size: small;">I will follow the prophet.</p> 
 <p style="font-size: small;">Daniel taught us that we should pray.</p>	 <p style="font-size: small;">John the Baptist taught us to be baptized.</p>	 <p style="font-size: small;">Samuel the Lamanite taught us to obey Heavenly Father.</p>	 <p style="font-size: small;">Joseph Smith taught us to read the scriptures.</p>

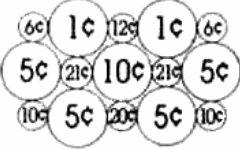
BINGO!!! They said it!

Listen carefully to what each speaker says. If you see their topic cover it with a bean, M&M, Skittle, piece of paper, whatever you can find! Try to get five in a row (up and down, sideways, or diagonally), corners, or blackout! But you need to listen carefully so you don't miss anything!

 <p>Jesus Christ</p>	 <p>Prayer</p>	 <p>Sacrament</p>	 <p>Missionaries</p>	 <p>Resurrection</p>
 <p>CTR</p>	 <p>Home</p>	 <p>Temple</p>	 <p>Hymns</p>	 <p>Word of Wisdom</p>
 <p>Joseph Smith</p>	 <p>Prophet</p>	 <p>FREE</p>	 <p>Atonement</p>	 <p>Bishop</p>
 <p>Faith</p>	 <p>Love</p>	 <p>Commandments</p>	 <p>Priesthood</p>	 <p>Baptism</p>
 <p>Tithing</p>	 <p>Scriptures</p>	 <p>Family</p>	 <p>Holy Ghost</p>	 <p>Pioneers</p>



Joseph Smith Saw Heavenly Father
and Jesus Christ



I Am a Child of God

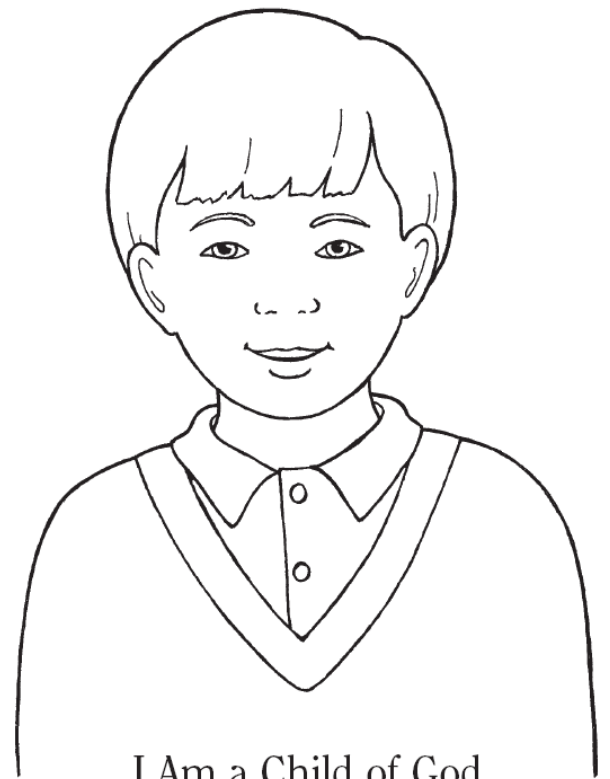
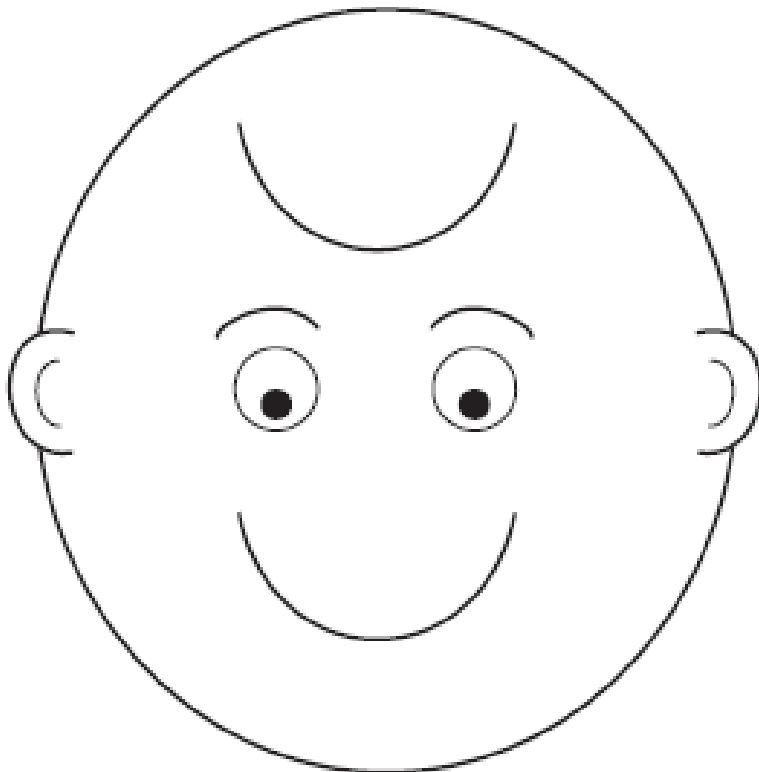

I Am a Child of God

I Belong to The Church of Jesus Christ of Latter-day Saints

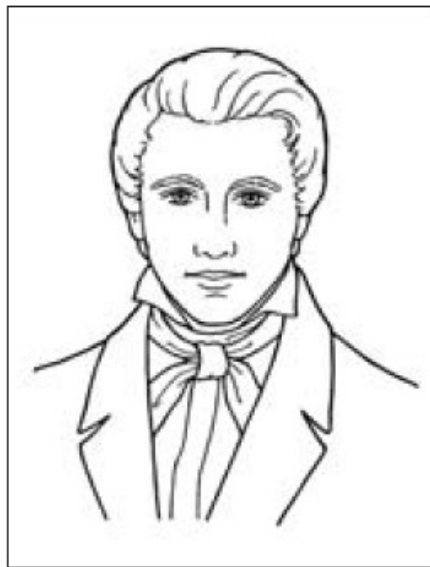

The Church of Jesus Christ
has prophets.

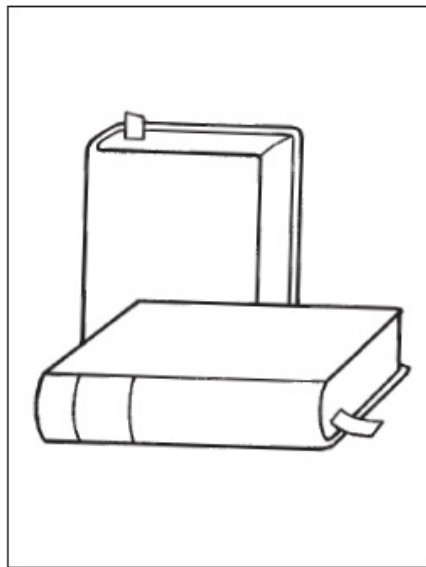

The Church of Jesus Christ
has scriptures.



FAMILY